



# X02 Series

SENSITIVE

1.25A SCRs

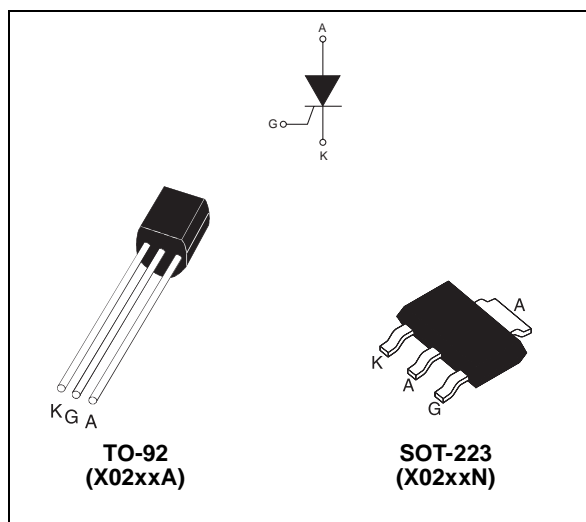
## MAIN FEATURES:

Symbol	Value	Unit
$I_{T(RMS)}$	1.25	A
$V_{DRM}/V_{RRM}$	600 and 800	V
$I_{GT}$	50 to 200	$\mu A$

## DESCRIPTION

Thanks to highly sensitive triggering levels, the X02 SCR series is suitable for all applications where the available gate current is limited, such as ground fault circuit interruptors, overvoltage crowbar protection in low power supplies, capacitive ignition circuits, ...

Available in through-hole or surface-mount packages, these devices are optimized in forward voltage drop and inrush current capabilities, for reduced power losses and high reliability in harsh environments.



## ABSOLUTE RATINGS (limiting values)

Symbol	Parameter	Value	Unit
$I_{T(RMS)}$	RMS on-state current (180° conduction angle)	TO-92 Tl = 55°C	1.25 A
		SOT-223 Ttab = 95°C	
$I_{T(AV)}$	Average on-state current (180° conduction angle)	TO-92 Tl = 55°C	0.8 A
		SOT-223 Ttab = 95°C	
$I_{TSM}$	Non repetitive surge peak on-state current	tp = 8.3 ms Tj = 25°C	25 A
		tp = 10 ms	
$I^2t$	$I^2t$ Value for fusing	tp = 10 ms Tj = 25°C	2.5 A <sup>2</sup> s
dI/dt	Critical rate of rise of on-state current $I_G = 2 \times I_{GT}$ , tr ≤ 100 ns	F = 60 Hz Tj = 125°C	50 A/μs
$I_{GM}$	Peak gate current	tp = 20 μs Tj = 125°C	1.2 A
$P_{G(AV)}$	Average gate power dissipation	Tj = 125°C	0.2 W
$T_{stg}$ Tj	Storage junction temperature range Operating junction temperature range		- 40 to + 150 - 40 to + 125 °C

## X02 Series

### ELECTRICAL CHARACTERISTICS (T<sub>j</sub> = 25°C, unless otherwise specified)

Symbol	Test Conditions		X02xx		Unit		
			02	05			
I <sub>GT</sub>	V <sub>D</sub> = 12 V R <sub>L</sub> = 140 Ω		MIN.	-	20	μA	
			MAX.	200	50		
V <sub>GT</sub>			MAX.	0.8		V	
V <sub>GD</sub>	V <sub>D</sub> = V <sub>DRM</sub> R <sub>L</sub> = 3.3 kΩ R <sub>GK</sub> = 1 kΩ	T <sub>j</sub> = 125°C	MIN.	0.1		V	
V <sub>RG</sub>	I <sub>RG</sub> = 10 μA		MIN.	8		V	
I <sub>H</sub>	I <sub>T</sub> = 50 mA R <sub>GK</sub> = 1 kΩ		MAX.	5		mA	
I <sub>L</sub>	I <sub>G</sub> = 1 mA R <sub>GK</sub> = 1 kΩ		MAX.	6		mA	
dV/dt	V <sub>D</sub> = 67 % V <sub>DRM</sub> R <sub>GK</sub> = 1 kΩ	T <sub>j</sub> = 110°C	MIN.	10	15	V/μs	
V <sub>TM</sub>	I <sub>TM</sub> = 2.5 A t <sub>p</sub> = 380 μs	T <sub>j</sub> = 25°C	MAX.	1.45		V	
V <sub>to</sub>	Threshold voltage		T <sub>j</sub> = 125°C	MAX.	0.9		V
R <sub>d</sub>	Dynamic resistance		T <sub>j</sub> = 125°C	MAX.	200		mΩ
I <sub>DRM</sub> I <sub>RRM</sub>	V <sub>DRM</sub> = V <sub>RRM</sub> R <sub>GK</sub> = 1 kΩ		T <sub>j</sub> = 25°C	MAX.	5		μA
			T <sub>j</sub> = 125°C		500		

### THERMAL RESISTANCES

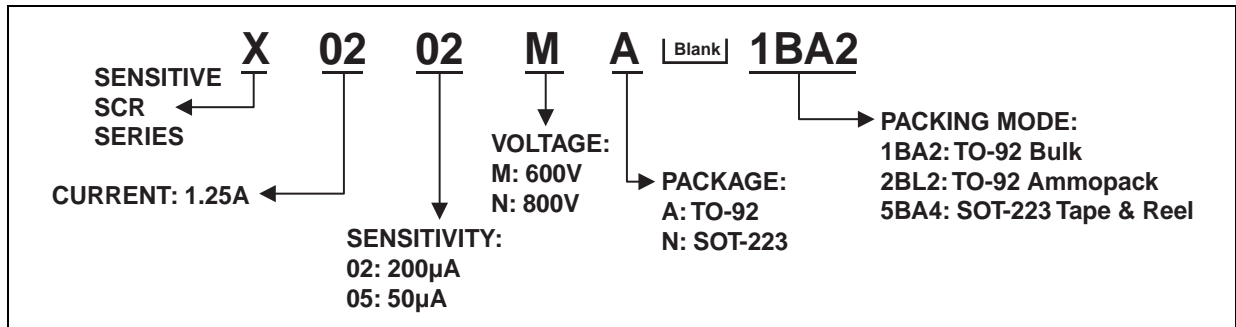
Symbol	Parameter		Value	Unit
R <sub>th(j-l)</sub>	Junction to leads (DC)	TO-92	60	°C/W
R <sub>th(j-t)</sub>	Junction to tab (DC)	SOT-223	25	
R <sub>th(j-a)</sub>	Junction to ambient (DC)	TO-92	150	
		S = 5 cm <sup>2</sup> SOT-223	60	

S = Copper surface under tab

### PRODUCT SELECTOR

Part Number	Voltage		Sensitivity	Package
	600 V	800 V		
X0202MA	X		200 μA	TO-92
X0202MN	X		200 μA	SOT-223
X0202NA		X	200 μA	TO-92
X0202NN		X	200 μA	SOT-223
X0205MA	X		50 μA	TO-92
X0205MN	X		50 μA	SOT-223
X0205NA		X	50 μA	TO-92
X0205NN		X	50 μA	SOT-223

ORDERING INFORMATION



OTHER INFORMATION

Part Number	Marking	Weight	Base Quantity	Packing mode
X02xxyA 1BA2	X02xxyA	0.2 g	2500	Bulk
X02xxyA 2BL2	X02xxyA	0.2 g	2000	Ammopack
X0202yN 5BA4	X2y	0.12 g	1000	Tape & reel
X0205yN 5BA4	X5y	0.12 g	1000	Tape & reel

Note: xx = sensitivity, y = voltage

Fig. 1: Maximum average power dissipation versus average on-state current.

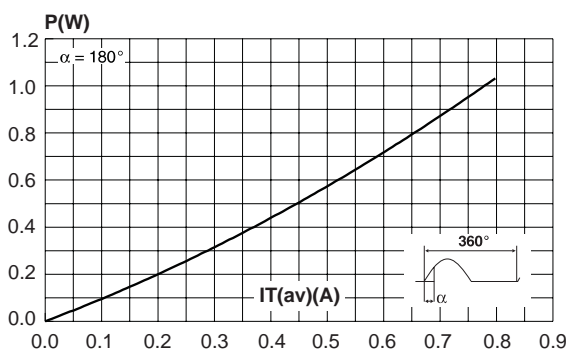
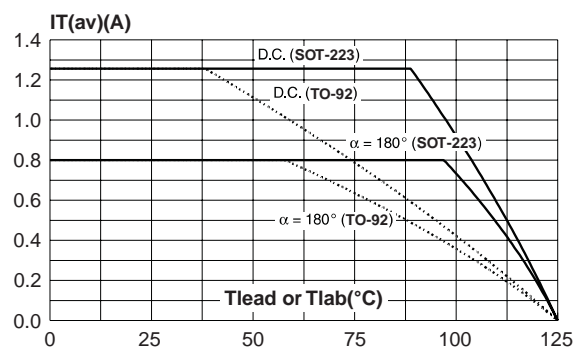
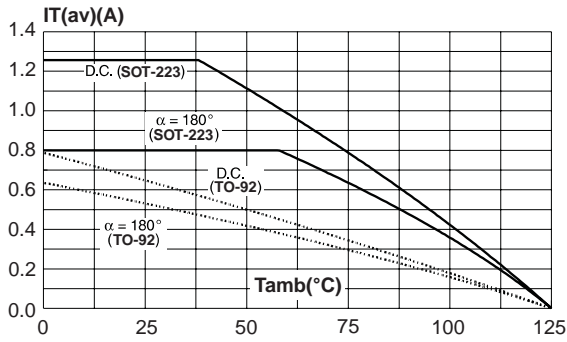


Fig. 2-1: Average and D.C. on-state current versus lead temperature (SOT-223/TO-92).

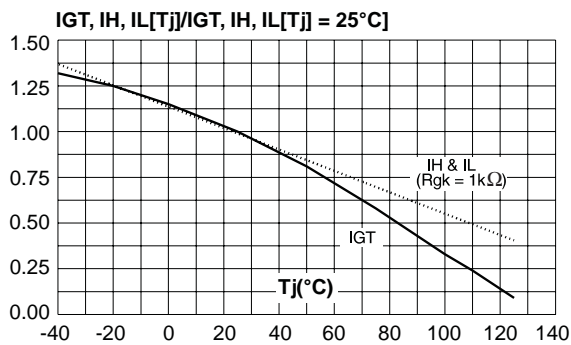


X02 Series

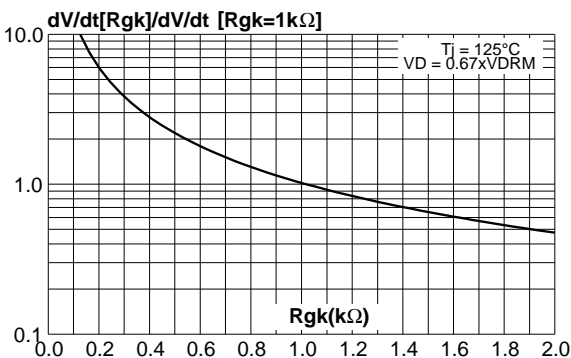
**Fig. 2-2:** Average and D.C. on-state current versus ambient temperature (device mounted on FR4 with recommended pad layout) (SOT-223/TO-92).



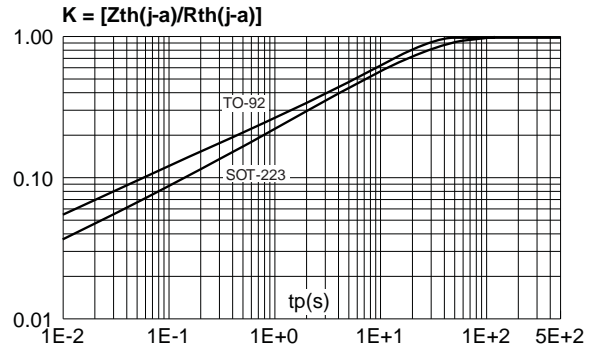
**Fig. 4:** Relative variation of gate trigger current, holding current and latching current versus junction temperature (typical values).



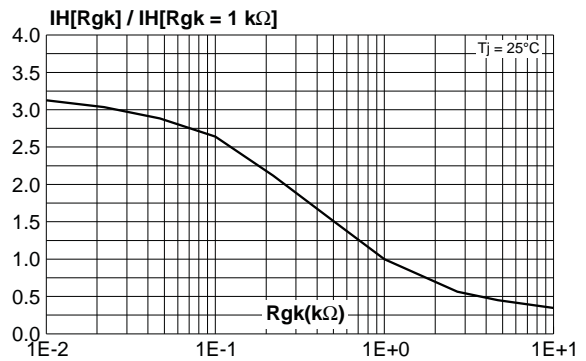
**Fig. 6:** Relative variation of dV/dt immunity versus gate-cathode resistance (typical values).



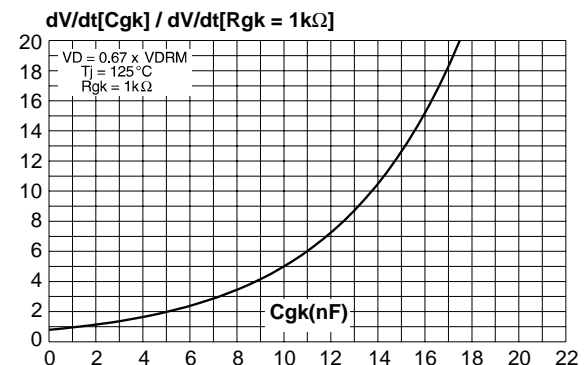
**Fig. 3:** Relative variation of thermal impedance junction to ambient versus pulse duration (SOT-223/TO-92).



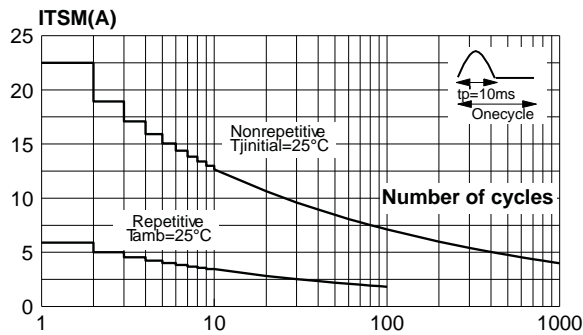
**Fig. 5:** Relative variation of holding current versus gate-cathode resistance (typical values).



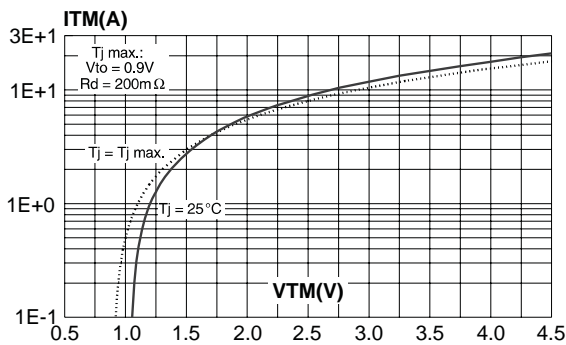
**Fig. 7:** Relative variation of dV/dt immunity versus gate-cathode capacitance (typical values).



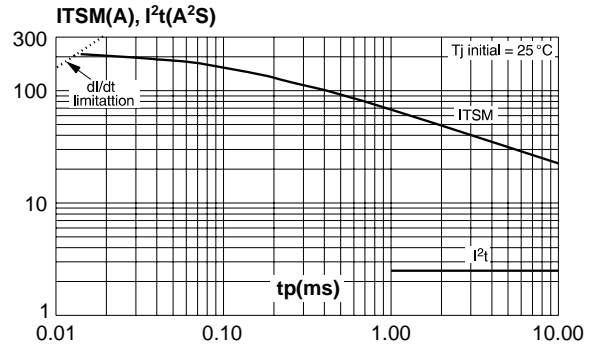
**Fig. 8:** Surge peak on-state current versus number of cycles.



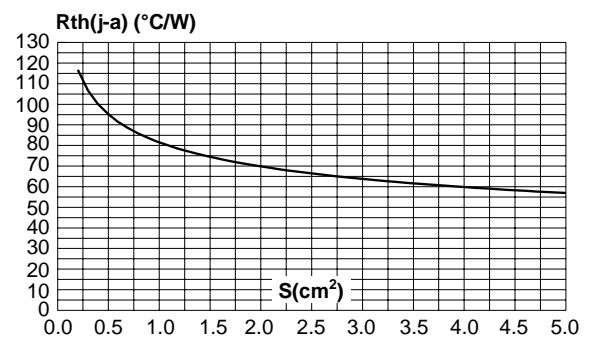
**Fig. 10:** On-state characteristics (maximum values).



**Fig. 9:** Non-repetitive surge peak on-state current for a sinusoidal pulse with width  $t_p < 10$  ms, and corresponding value of  $I^2t$ .

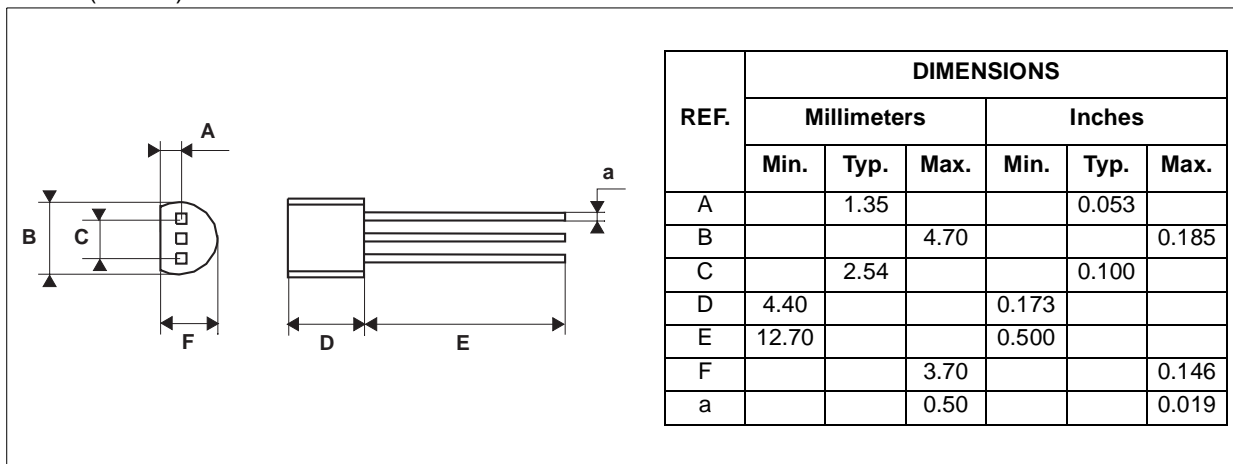


**Fig. 11:** Thermal resistance junction to ambient versus copper surface under tab (Epoxy printed circuit board FR4, copper thickness: 35  $\mu$ m) (SOT-223).



**PACKAGE MECHANICAL DATA**

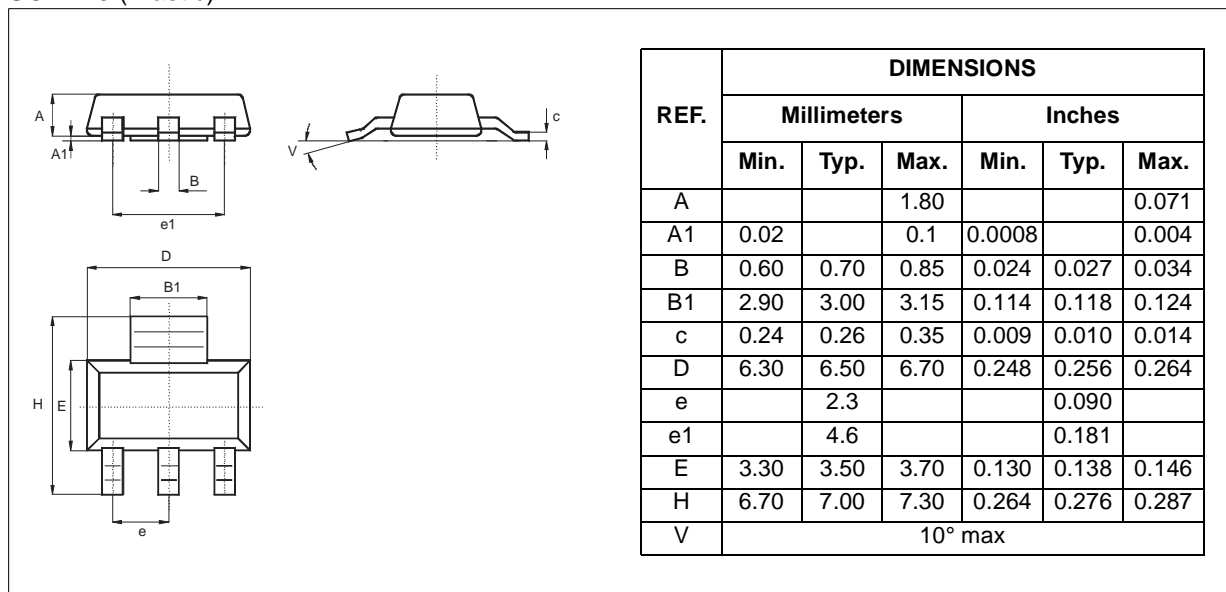
TO-92 (Plastic)



**X02 Series**

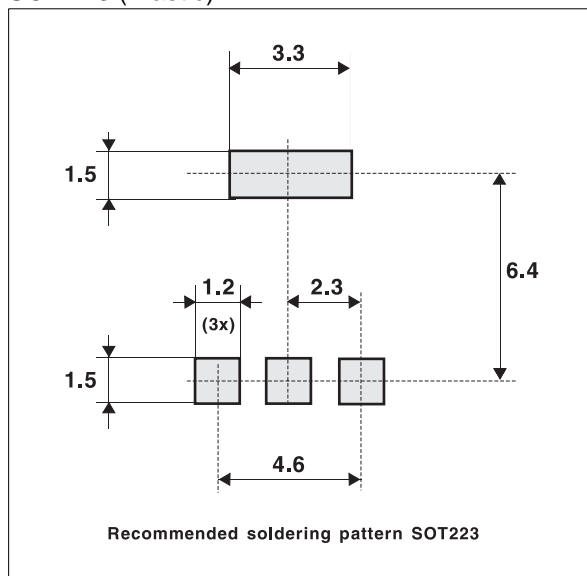
**PACKAGE MECHANICAL DATA**

SOT-223 (Plastic)



**FOOTPRINT DIMENSIONS (in millimeters)**

SOT-223 (Plastic)



Information furnished is believed to be accurate and reliable. However, STMicroelectronics assumes no responsibility for the consequences of use of such information nor for any infringement of patents or other rights of third parties which may result from its use. No license is granted by implication or otherwise under any patent or patent rights of STMicroelectronics. Specifications mentioned in this publication are subject to change without notice. This publication supersedes and replaces all information previously supplied. STMicroelectronics products are not authorized for use as critical components in life support devices or systems without express written approval of STMicroelectronics.

© The ST logo is a registered trademark of STMicroelectronics

© 2000 STMicroelectronics - Printed in Italy - All Rights Reserved

STMicroelectronics GROUP OF COMPANIES  
 Australia - Brazil - China - Finland - France - Germany - Hong Kong - India - Italy - Japan - Malaysia - Malta - Morocco  
 Singapore - Spain - Sweden - Switzerland - United Kingdom

<http://www.st.com>